

S62



THE MOST COMPLETE UNIVERSAL SENSOR IN A COMPACT 50X50 MM HOUSING

- Sensors with red, infrared LED or LASER emission
- Background suppression from 3 cm to 2 m
- Polarized retroreflective up to 20 m
- Multivoltage 24-240Vac/24-60Vdc with Relay output
- NPN/PNP output NO-NC configuration

APPLICATIONS

- Processing and Packaging machinery
- Conveyor lines, material handling



S62		
Through beam	0...25 m	
Retroreflective (on R2 reflector)	0,1...13 m	
Polarized retroreflective	0,1...8 m	
	0,3...20 m (class 2 LASER)	
Diffuse proximity	short 0...900 mm, long 0...2000 mm	
	0...900 mm (class 2 LASER)	
	short 30...300 mm	
	medium 60...600 mm	
	long 60...1200 mm	
	very long 200...2000 mm	
Background suppression	short LASER 30...150 mm (class 2 LASER)	
	long LASER 50...350 mm (class 2 LASER)	
Power supply	Vdc	10...30 V
	Vac	
	Vac/dc	24/240 Vac/24...60 Vdc
Output	PNP	•
	NPN	•
	NPN/PNP	•
	relay	•
	other	•
Connection	cable	•
	connector	•
	pig-tail	
Approximate dimensions (mm)	18x50x50	
Housing material	ABS	
Mechanical protection	IP67	

TECHNICAL DATA

Power supply	10 ... 30 Vdc (mod. S62...2/5) 24...240 Vac/ 24...60 Vdc (mod. S62...1)
Ripple	2 Vpp max. (mod. S62...2/5), 10% max. (mod. S62...1)
Consumption (output current excluded)	30 mA max. (mod. S62...2/5) 3 VA max. (mod. S62...1)
Light emission	red LED 640 nm (mod. S62-PA...A/B/C/G/M01/M05/M11/M15) IR LED 880 nm (mod. S62-PA...M21/M25/M31/M35) red Laser 645...665 nm (mod. S62-PL)
Setting	sensitivity adjustment trimmer
Operating mode	mono-turn LIGHT/DARK trimmer (mod. S62...RX/PN)
Indicators	yellow OUTPUT LED green STABILITY LED, POWER LED (S62...G)
Output	PNP or NPN N.O./N.C. (mod. S62...PP/NN); NPN/PNP (mod. S62...PN); electromechanical SPDT 250 Vac/30 Vdc (mod. S62...RX)
Output current	100 mA max. (mod. S62...2/5), 2 A max. (mod. S62...1)
Saturation voltage	2 V max. (mod. S62...2/5)
Response time	25 ms (mod. S62...1) 1,5 ms (mod. S62...M3x) 1 ms (mod. S62...2/5-F/G/M2x) 500 µs (mod. S62-PA...2/5-A/B/C/M0x/M1x) 200 µs (mod. S62-PL...B/C/M11) 140 µs (mod. S62-PL...M01)
Switching frequency	20 Hz (mod. S62...1) 330 Hz (mod. S62...M3x) 500 Hz (mod. S62...2/5-F/G/M2x) 1 kHz (mod. S62-PA...2/5-A/B/C/M0x/M1x) 2,5 kHz (mod. S62-PL...B/C/M11) 3,5 kHz (mod. S62-PL...M01)
Connection	M12 4-pole connector, 2 m Ø 4 mm cable vers., 2 m Ø 5 mm cable vers.
Dielectric strength	500 Vac 1 min., between electronics and housing
Insulation resistance	>20 MΩ 500 Vdc, between electronics and housing
Mechanical protection	IP67
Ambient light rejection	According to EN 60947-5-2
Vibrations	0.5 mm amplitude, 10 ... 55 Hz frequency, for each axis (EN60068-2-6)
Shock resistance	11 ms (30G) 6 shock for every axis (EN60068-2-27)
Housing material	ABS
Lens material	PMMA window, polycarbonate lens
Operating temperature	-10 ... 55 °C
Storage temperature	-20 ... 70 °C
Weight	40 g max. conn. vers., 90 max. cable vers.

DIMENSIONS

Background suppression

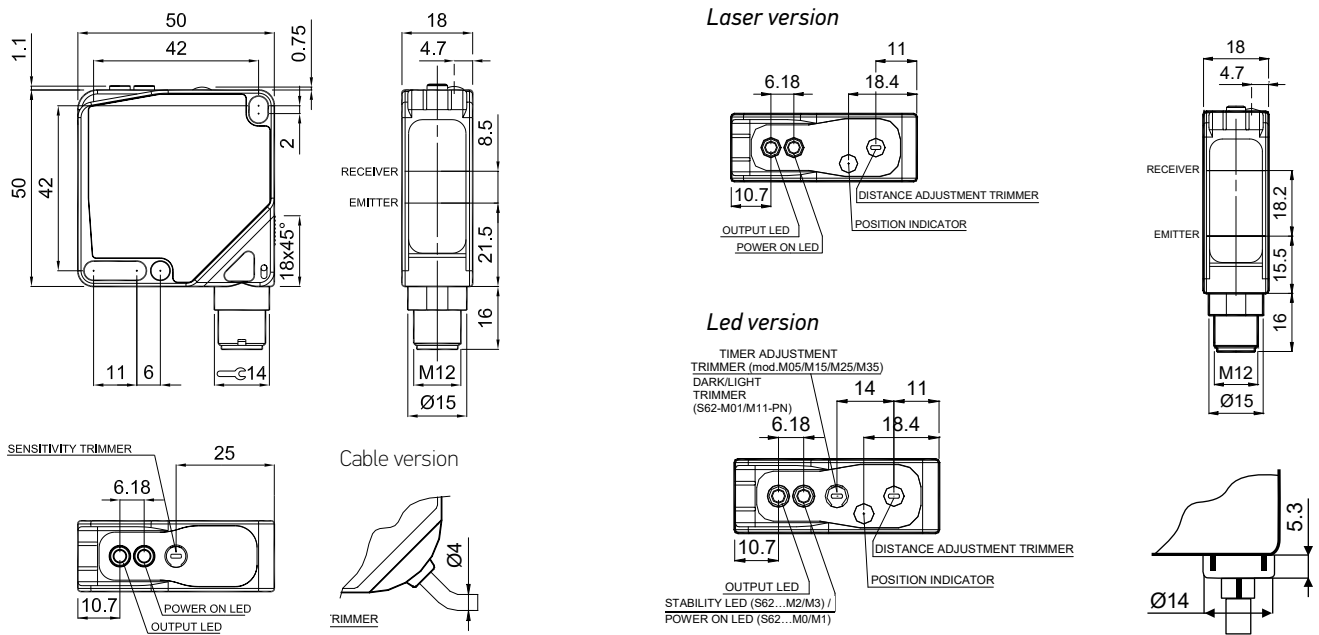

AC Models cable output

CONNECTIONS

VDC MODELS

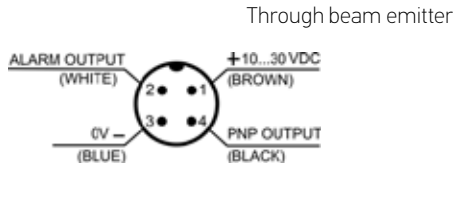

NPN/PNP version

AC MODELS

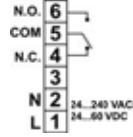

DC MODELS

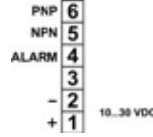

M12 CONNECTOR

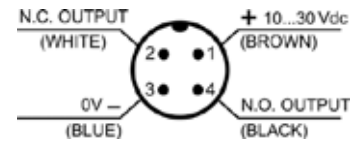

VAC MODELS



INDICATORS AND SETTINGS

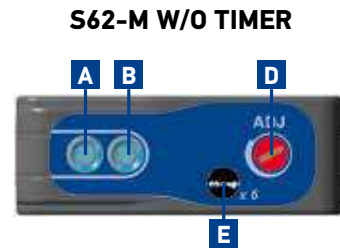
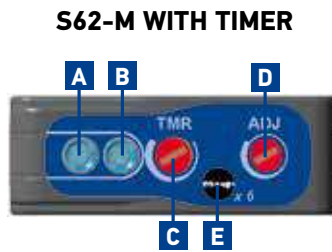
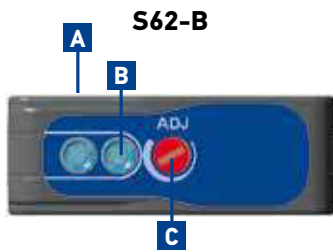

- A** Output status LED
- B** Stability LED or Power ON LED (laser vers.)
- C** Timer adjustment trimmer

- D** Distance adjustment trimmer
- E** Geared numeric scale
- F** M12 connector output
- G** Cable output

DETECTION DIAGRAMS OF MODELS WITH LED EMISSION

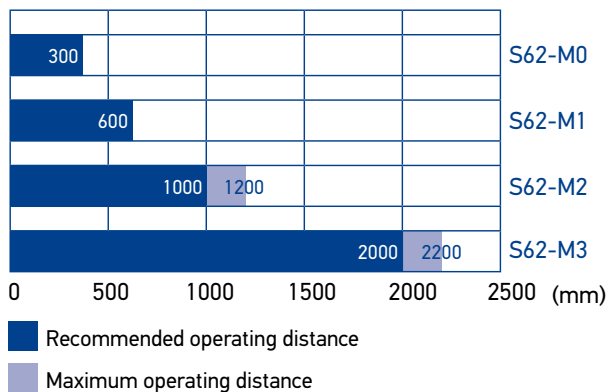
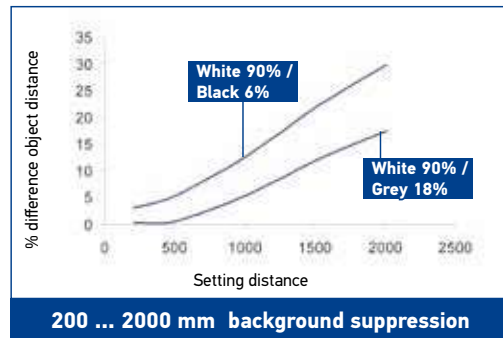
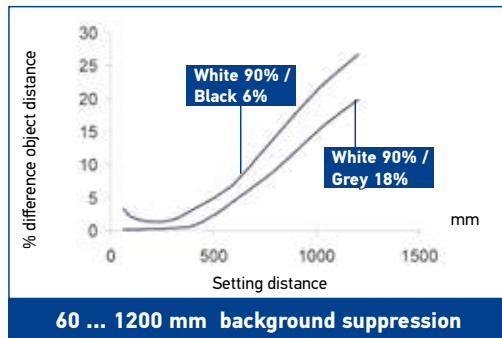
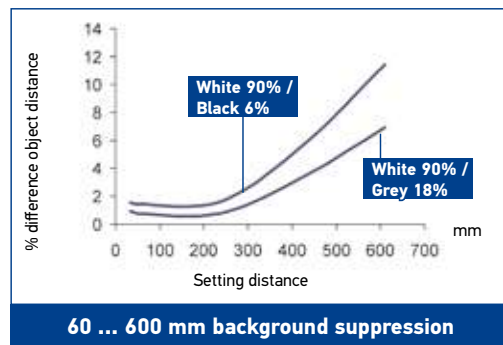
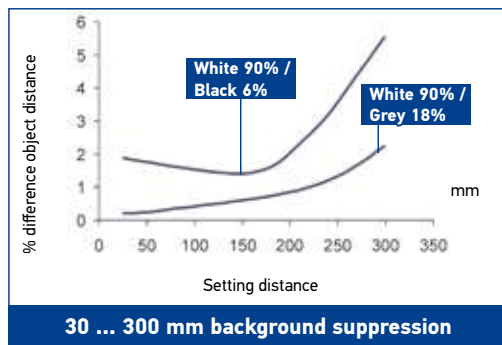
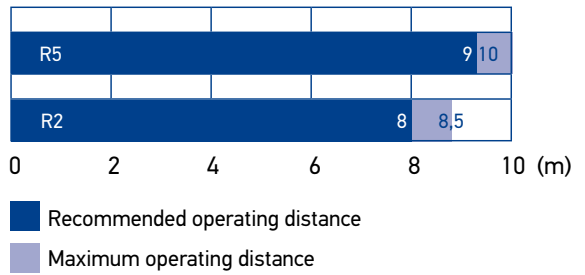
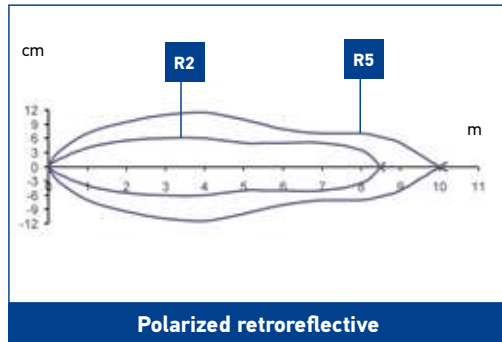
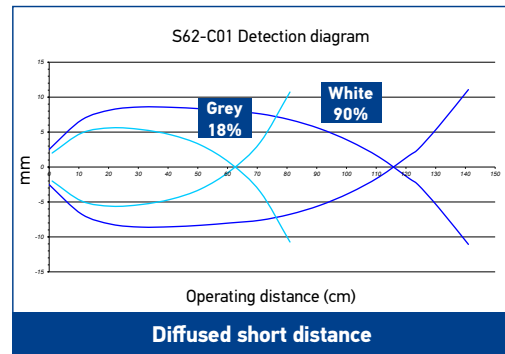
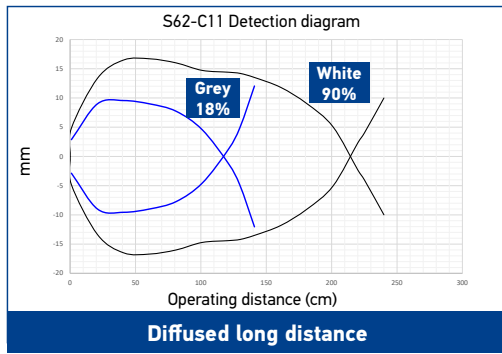

DETECTION DIAGRAMS OF MODELS WITH LASER EMISSION

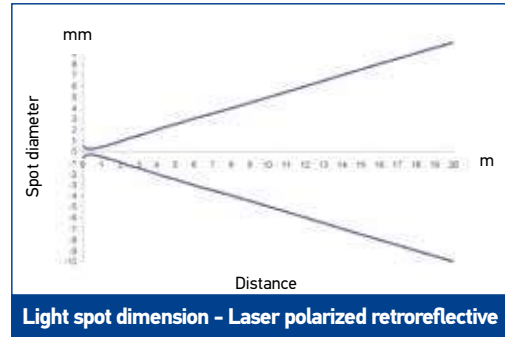
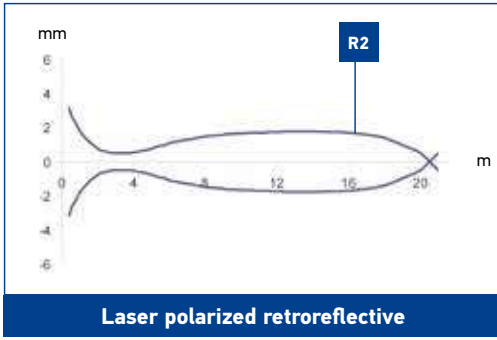

Reflector operating distances (m)

R1	R2	R6	R7 / R20	R8
0.3 ... 16	0.3 ... 20	0.4 ... 22	0.3 ... 22	0.2 ... 2

The use of the RT3970 reflecting tape is suggested.

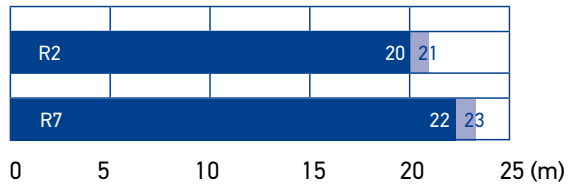

- Recommended operating distance
- Maximum operating distance

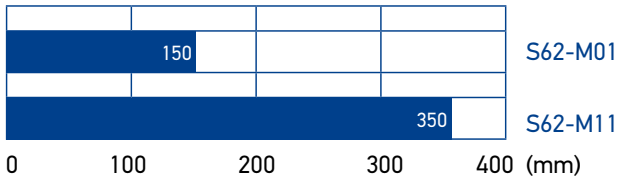
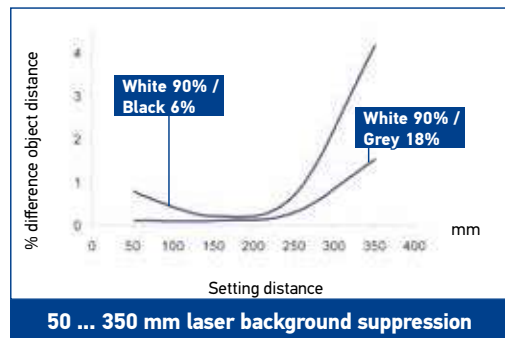
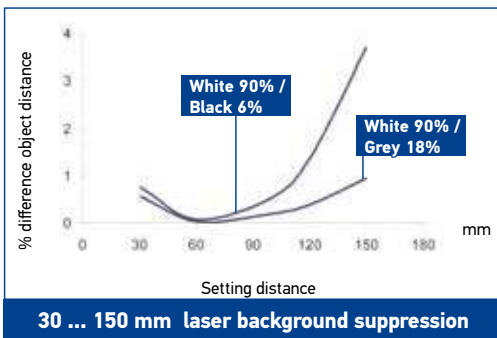

- Recommended operating distance
- Maximum operating distance

MODEL SELECTION AND ORDER INFORMATION

OPTIC FUNCTION	EMISSION	CONNECTION	SETTING	OUTPUT	MODEL	ORDER No.	
Retroreflective	LED (red 640nm)	2m Cable	sensitivity trimmer (mono turn)	PNP/NPN	S62-PA-2-A01-PN	956211240	
		M12 Connector		PNP/NPN	S62-PA-5-A01-PN	956211310	
		Vac relay	mono-turn light/dark trimmer	Relay	S62-PA-1-A01-RX	956211180	
Polarized retroreflective	LED (red 640nm)	2m Cable	sensitivity trimmer (mono-turn)	PNP/NPN	S62-PA-2-B01-PN	956211250	
		M12 Connector		PNP	S62-PA-2-B01-PP	956211010	
				NPN	S62-PA-5-B01-NN	956211020	
		PNP/NPN		S62-PA-5-B01-PN	956211320		
	Vac relay	mono-turn light/dark trimmer	Relay	S62-PA-1-B01-RX	956211190		
	LASER	M12 Connector	mono-turn light/dark trimmer	NPN	S62-PL-5-B01-NN	956211100	
Short diffused proximity	LED (red 640nm)	2m Cable	sensitivity trimmer (mono-turn)	PNP	S62-PA-2-C01-PN	956211260	
		M12 Connector		PNP	S62-PA-2-C01-PP	956211380	
				NPN	S62-PA-5-C01-NN	956211500	
		PNP/NPN		S62-PA-5-C01-PN	956211330		
		PNP		S62-PA-5-C01-PP	956211460		
		Vac relay		mono-turn light/dark trimmer	Relay	S62-PA-1-C01-RX	956211200
	LASER	2m Cable	sensitivity trimmer (mono-turn)	NPN	S62-PL-2-C01-NN	956211440	
		M12 Connector		PNP	S62-PL-2-C01-PP	956211400	
				NPN	S62-PL-5-C01-NN	956211520	
		PNP		S62-PL-5-C01-PP	956211480		
		NPN		S62-PA-2-C11-NN	956211430		
		PNP/NPN		S62-PA-2-C11-PN	956211270		
Long diffused proximity	LED (red 640nm)	2m Cable	sensitivity trimmer (mono turn)	PNP	S62-PA-2-C11-PP	956211390	
		M12 Connector		NPN	S62-PA-5-C11-NN	956211510	
				PNP/NPN	S62-PA-5-C11-PN	956211340	
		PNP		S62-PA-5-C11-PP	956211470		
		Vac relay		mono-turn light/dark trimmer	Relay	S62-PA-1-C11-RX	956211210
		NPN		S62-PA-2-F01-NN	956211450		
Through beam receiver	-	2m Cable	sensitivity trimmer (mono turn)	PNP/NPN	S62-PA-2-F01-PN	956211290	
		M12 Connector		PNP	S62-PA-2-F01-PP	956211410	
				NPN	S62-PA-5-F01-NN	956211530	
		PNP/NPN		S62-PA-5-F01-PN	956211360		
		PNP		S62-PA-5-F01-PP	956211490		
		Vac relay		mono-turn light/dark trimmer	Relay	S62-PA-1-F01-RX	956211220
Through beam emitter	-	2m Cable	sensitivity trimmer (mono turn)	-	S62-PA-2-G00-XG	956211300	
		M12 Connector			S62-PA-5-G00-XG	956211370	
		Vac relay			S62-PA-1-G00-XX	956211230	
Background suppression (short distance)	LED (red 640nm)	2m Cable	6 turns distance adjustment trimmer	PNP/NPN	S62-PA-2-M01-PN	956211280	
		M12 Connector		PNP	S62-PA-2-M01-PP	956201841	
				NPN	S62-PA-5-M01-NN	956201811	
		PNP/NPN		S62-PA-5-M01-PN	956211350		
		PNP		S62-PA-5-M01-PP	956201831		
		NPN		S62-PA-5-M05-NN	956201801		
	PNP	S62-PA-5-M05-PP	956201821				
	LASER	M12 Connector	4 turns distance adjustment trimmer	NPN	S62-PL-5-M01-NN	956211120	
	PNP	S62-PL-5-M01-PP	956211130				
PNP	S62-PA-2-M11-PP	956201891					
Background suppression (medium distance)	LED (red 640nm)	2m Cable	6 turns distance adjustment trimmer	NPN	S62-PA-5-M11-NN	956201861	
		M12 Connector		PNP	S62-PA-5-M11-PP	956201881	
				NPN	S62-PA-5-M15-NN	956201851	
	PNP	S62-PA-5-M15-PP	956201871				
	LASER	M12 Connector	6 turns distance adjustment trimmer	NPN	S62-PL-5-M11-NN	956211140	
	PNP	S62-PL-5-M11-PP	956211150				
Background suppression (long distance)	LED (infrared 880nm)	2m Cable	6 turns distance adjustment trimmer	PNP	S62-PA-2-M21-PP	956201940	
		M12 Connector		NPN	S62-PA-5-M21-NN	956201910	
				PNP	S62-PA-5-M21-PP	956201900	
		NPN		S62-PA-5-M25-NN	956201930		
		PNP		S62-PA-5-M25-PP	956201920		
		PNP		S62-PA-2-M31-PP	956211050		
Background suppression (very long distance)	LED (infrared 880nm)	2m Cable	6 turns distance adjustment trimmer	NPN	S62-PA-5-M31-NN	956211060	
		M12 Connector		PNP	S62-PA-5-M31-PP	956211070	
				NPN	S62-PA-5-M35-NN	956211080	
		PNP		S62-PA-5-M35-PP	956211090		

ACCESSORIES

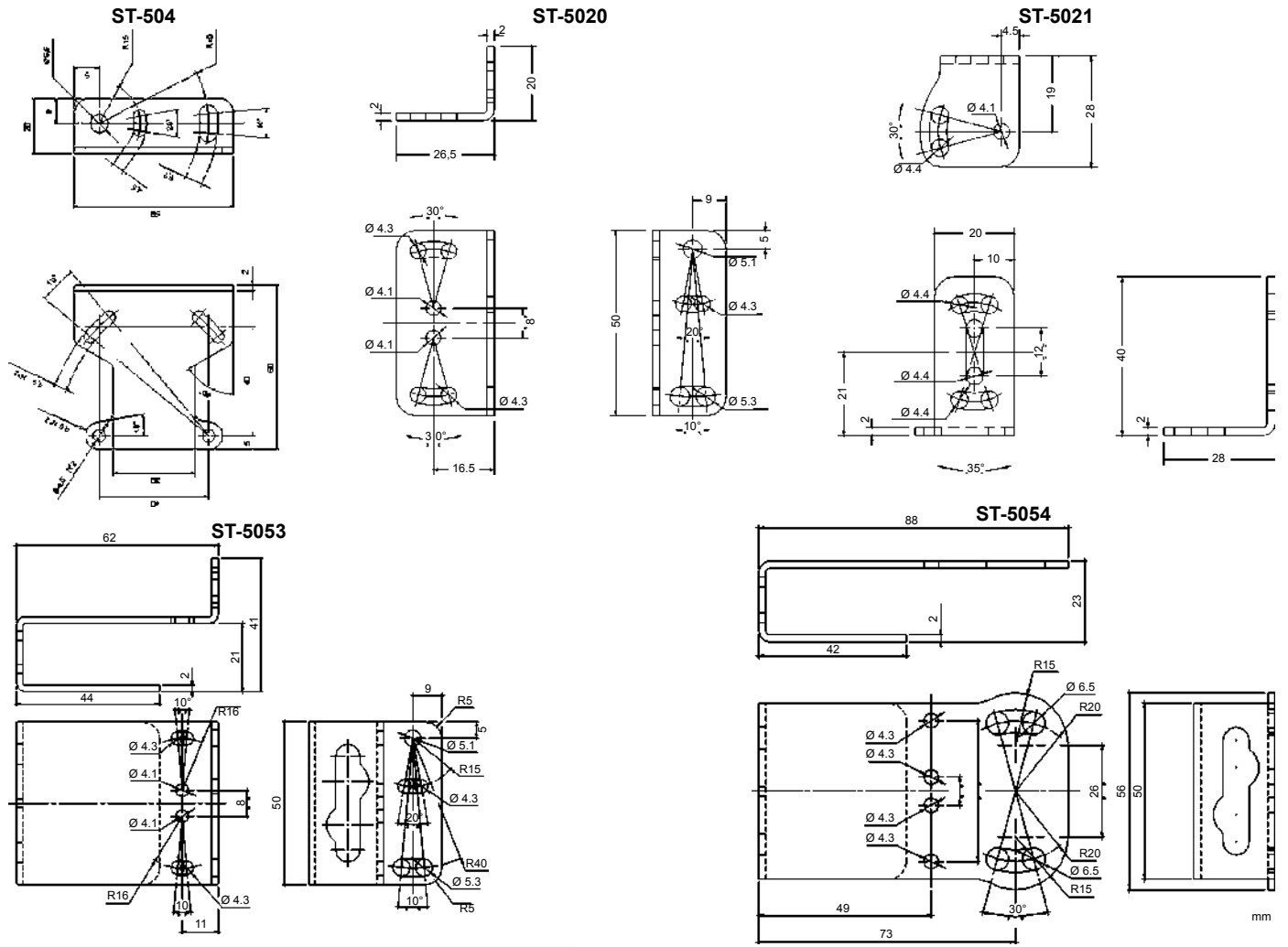

MODEL	DESCRIPTION	ORDER No.
ST-5020	mounting bracket	95ACC5330
ST-5021	mounting bracket	95ACC5340
ST-504	mounting bracket	95ACC2820
ST-5053	protective bracket	95ACC2410
ST-5054	protective bracket	95ACC2420
JOINT-S62	protective bracket with jointed support	95ACC2430

CABLES

TYPE	DESCRIPTION	LENGTH	MODEL	ORDER No.
Axial M12 Connector	4-pole, grey, P.V.C.	3 m	CS-A1-02-G-03	95A251380
		5 m	CS-A1-02-G-05	95A251270
		7 m	CS-A1-02-G-07	95A251280
		10 m	CS-A1-02-G-10	95A251390
	4-pole, P.U.R.	2 m	CS-A1-02-R-02	95A251540
		5 m	CS-A1-02-R-05	95A251560
Radial M12 Connector	4-pole, grey, P.V.C.	3 m	CS-A2-02-G-03	95A251360
		5 m	CS-A2-02-G-05	95A251240
		7 m	CS-A2-02-G-07	95A251245
		10 m	CS-A2-02-G-10	95A251260
	4-pole, P.U.R.	2 m	CS-A2-02-R-02	95A251550
		5 m	CS-A2-02-R-05	95A251570
Radial M12 Connector with LED (for PNP N.O. sensors)	4-pole, grey, P.V.C.	3 m	CS-A2-12-G-03	95A251400
		5 m	CS-A2-12-G-05	95A251350
		10 m	CS-A2-12-G-10	95A251370
Axial M12 Connector	4-pole, shielded, black, P.V.C.	3 m	CV-A1-22-B-03	95ACC1480
		5 m	CV-A1-22-B-05	95ACC1490
		10 m	CV-A1-22-B-10	95ACC1500
		15 m	CV-A1-22-B-15	95ACC2070
		25 m	CV-A1-22-B-25	95ACC2090
Radial M12 Connector	4-pole, shielded, black, P.V.C.	3 m	CV-A2-22-B-03	95ACC1540
		5 m	CV-A2-22-B-05	95ACC1550
		10 m	CV-A2-22-B-10	95ACC1560
Axial M12 Connector	4-pole, U.L., black, P.V.C.	3 m	CS-A1-02-U-03	95ASE1120
		5 m	CS-A1-02-U-05	95ASE1130
		10 m	CS-A1-02-U-10	95ASE1140
		15 m	CS-A1-02-U-15	95ASE1150
		25 m	CS-A1-02-U-25	95ASE1160
Radial M12 Connector	4-pole, black	Connector- not cabled	CS-A1-02-B-NC	G5085002
Radial M12 Connector	4-pole, black	Connector- not cabled	CS-A2-02-B-NC	G5085003